

BX 1150







napätie, príkon
230V / 50Hz,
1150W

otáčky nástroja
250 - 500min⁻¹

energia príklepu
10 Joule
počet úderov
1.450 - 2.900min⁻¹

hmotnosť
8,16 kg

PRACOVNÉ FUNKCIE

-   vŕtanie s príklepom
-   sekanie
-   nastavenie polohy sekáča

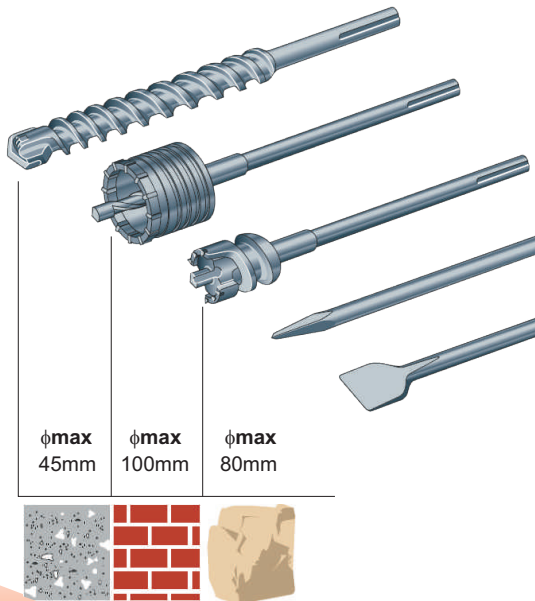

φmax 45mm φmax 100mm φmax 80mm

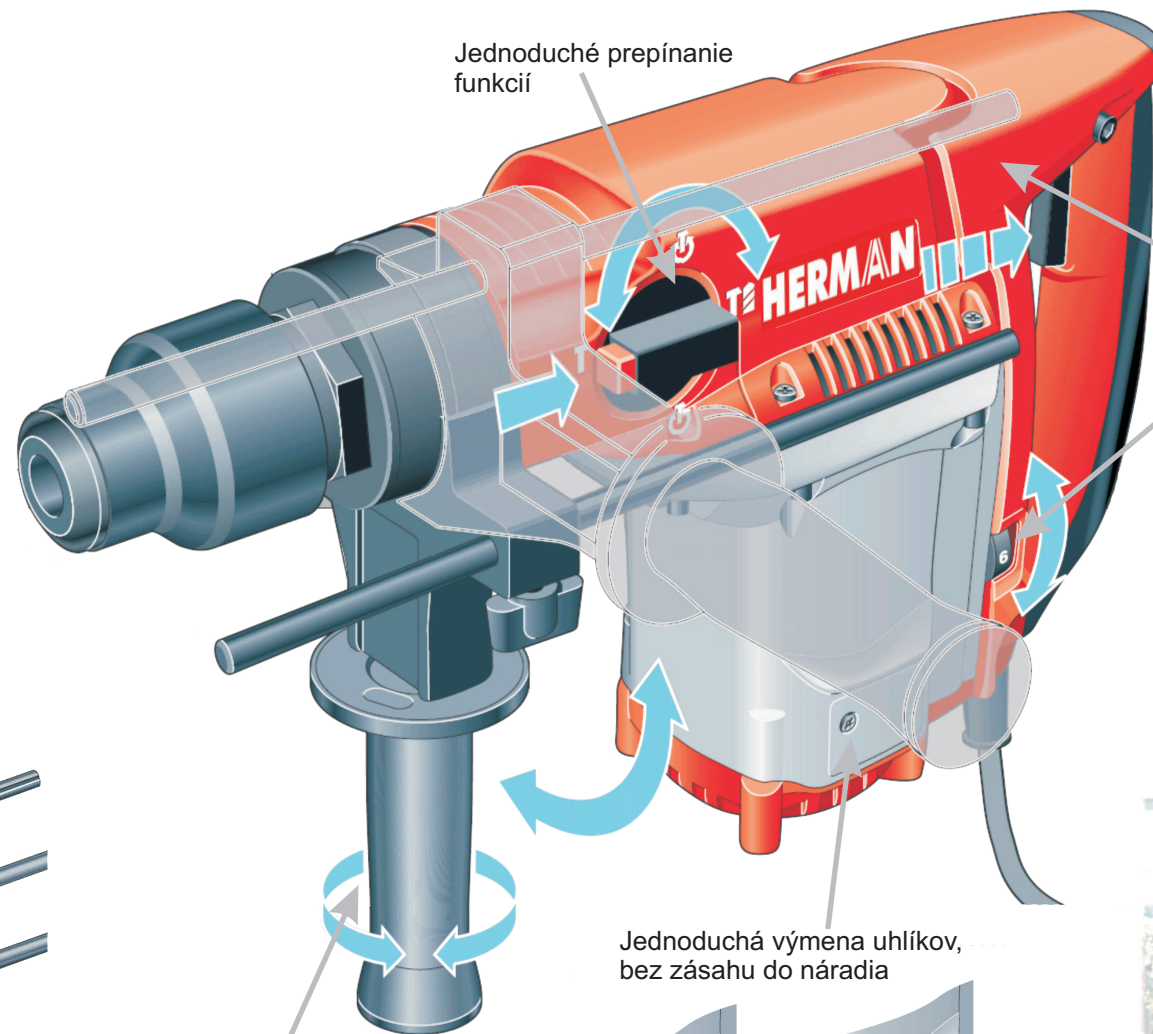

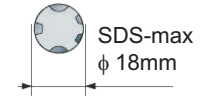

Jednoduché prepínanie funkcií

Systém upínania SDS-max



Odpružená rukoväť znižuje vibrácie

Elektronika s rozbehom umožňuje nastavenie pracovných otáčok stroja

	T min ⁻¹	min ⁻¹	Ø
1	1450	250	
↕	⋮	⋮	⋮
6	2900	500	

Jednoduchá výmena uhlíkov, bez zásahu do náradia

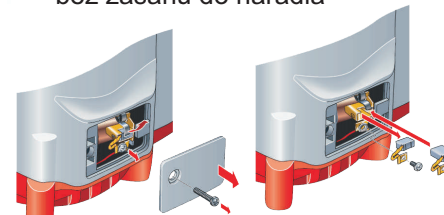

Pohodlná prídavná rukoväť, s jednoduchým polohovaním



kombinované kladivo